

FACETS / TMG LASER DEFENDER α-17



Installation & Operation Manual

Jan 2023 Edition
(rev 2)

© 2023 All rights reserved

Facets/TMG North America

www.facetstmg.com

TMG, the TMG logo, and other TMG marks are owned by Facets TMG and may be registered. All other trademarks are properties of their respective owners.

2023V2

Table of Contents

Introduction	2
Installation	4
Operation.....	8
Troubleshooting.....	11
Warranty.....	12
Appendix.....	13

Introduction

Thank you for purchasing the TMG A-17, one of the most innovative and sophisticated devices in its category today.

Please be sure to read this manual to familiarize yourself with the features and operation of this product. Enjoy the trip and drive safely.



This TMG system is a class 1M laser product. Never look at the heads closely while powered on! We recommend wearing Laser protected eye wear when testing the jamming function with police laser guns.



Motorists are expected to exercise all caution while using this product and obey all applicable traffic laws.

Check your State and local laws on usage. We encourage you to disable your jamming function as soon as possible once you slow down. This can be done by the RCV button, front power button, or the RCV tab on the app. Running in the “test mode” is meant for laser jamming *testing only*, is in full time jamming mode, and could result in suspicion that the LIDAR operator is being jammed. *Auto-sleep* mode is the default setting and its use is highly recommended with an *Auto-kill* feature to “Receive only mode” after 4 seconds. Jamming duration can be adjusted by the adjustable Auto-kill settings through your smartphone’s app.



CPU accepts 12V power sources only. Any other power source will damage the product permanently, and will void your warranty.

Specifications

Input.....	DC 12V
Laser Wavelength	905nm
Optical Peak Power	Up to 75 W
Communication	BT3.0/4.0 Compatible
Operation Temperature.....	-10°F~150°F / -25°C~70°C
FCC ID	2ARGWTMGA15
Fuse size	3A 250V Glass 0.2 x 0.78 inch / 5 x 20 mm (2amp) (F2A)

Required Tools for Installation

- T-10 torque bit or Allen wrench
- Cordless screw driver - to mount the brackets
- Small screws - to mount the brackets
- Velcro, 3M Dual Lock, or 3M tape to mount the CPU
- Tape measure- to measure out the head separation
- Electrical tape - wrap up the head connectors and the wire to feed through the firewall.
- Metal wire to feed the wires through the firewall. (Optional)

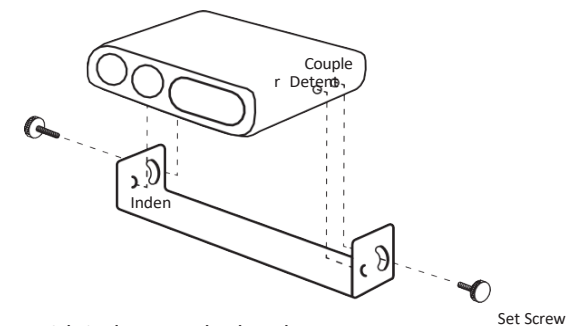

Detent on transponder lines up with indent on the bracket. Position is locked into place with the set screw.

CHAPTER 1: Installation

- 1 Make sure the heads are positioned approximately at the same height as the license area. Recommended separation is at least 24 inches. While the a-17 now allows them to be positioned closer than the a-15, you will want the greatest coverage with sufficient head separation.
- 2 Use the included green bubble level tool to make sure the heads are horizontally positioned, are facing straight forward, and ensure all torque screws are tight.
- 3 When using a third VPR head, install the head in the center of both heads. The a-17 now permits more flexibility with its mounting and can now be positioned at the same height or lower without creating interference or performance issues.
- 4 The CPU computer supports up to 6 heads in total (4 standard and 2 VPR).

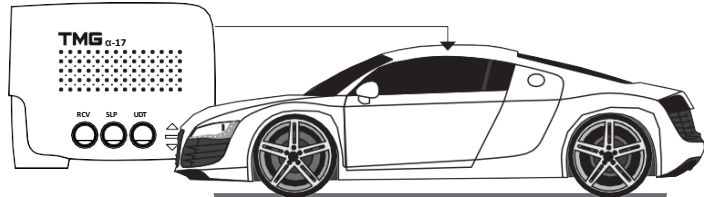

Controller is installed inside the cabin.

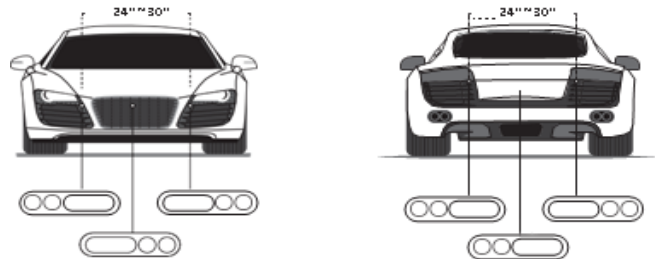

Use optional third VPR head for maximum protection from variable pulse rate lasers.

BMW owners have the option of installing the heads vertically.

The standard heads now include two diodes, one for ground-level targeting and the other for overpass targeting. The VPR head now consists of three diodes.

Make sure transponders are facing straight forward.

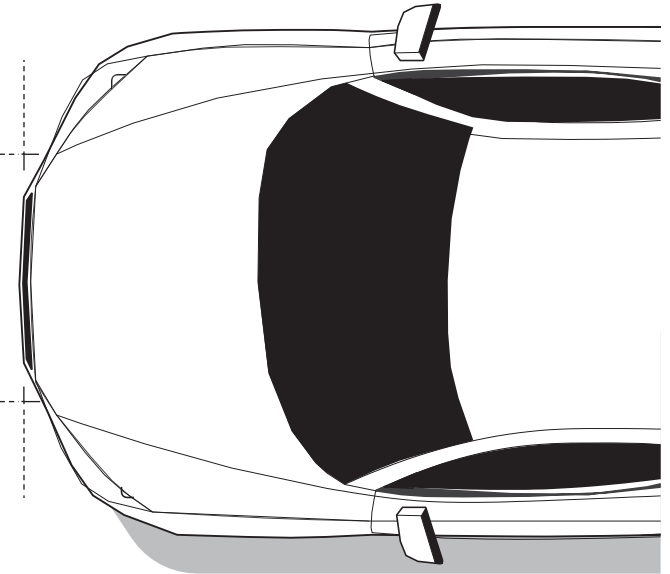

Make sure the heads are horizontal and level by using the bubble level included in the package.



Cables

Arrows on cable align for proper fit.



Changing the Lens cover

Replace the lenses only as needed. To replace an old lens cover with a new one, use a pin to pry open the old lens cover to replace it.

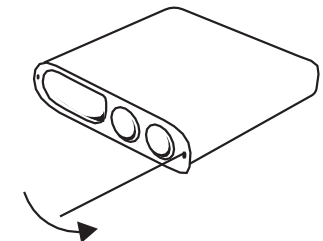

Installation list

Trim removal tool	16g ring connectors
Flex claw tool	Add-a-fuse (optional)
Flashlight	Heat shrink (assorted sizes)
Zip ties	3M mounting tape
Wire strippers	Bubble level
16g plug connectors	

Pre-planning

Determine best location for CPU Controller, laser sensors and wire routing
Tip: It's a good idea to label the connector locations on the sensor wires at both the connector end and the sensor head to help with troubleshooting should there be any potential performance problems subsequently.

The following is a rough guideline for hard wiring the TMG

Installation

1. Park on level ground
2. Shut off vehicle
3. Disconnect negative battery terminal.
4. Remove trim pieces for access to wiring passages.
5. Run sensor wires from the mounting location to the CPU controller. (Be sure to keep wires secured in the engine bay and away from moving parts).
6. Access to passages through the fire wall can be achieved by piggy backing on an existing wire route.
7. Use flex claw tool to pull wires through the firewall and into the cabin.
8. Any extra length of sensor wire should be coiled loosely and secured with a zip tie to the vehicle, under the dash or behind the glove compartment.
9. Wire the power to either the positive battery terminal or a switchable fuse in the fuse box with an "add-a-fuse". (Be sure to procure the right size add-a-fuse for your fuse bank.)
10. Find a solid part of the vehicle's frame that's in a discreet location, drill a small hole then connect the ground wire to the frame with a loop connector and an appropriately sized machine screw.
11. Mount CPU controller in the cabin in an area where it can be accessed directly.
12. Connect negative battery terminal
13. Start the vehicle

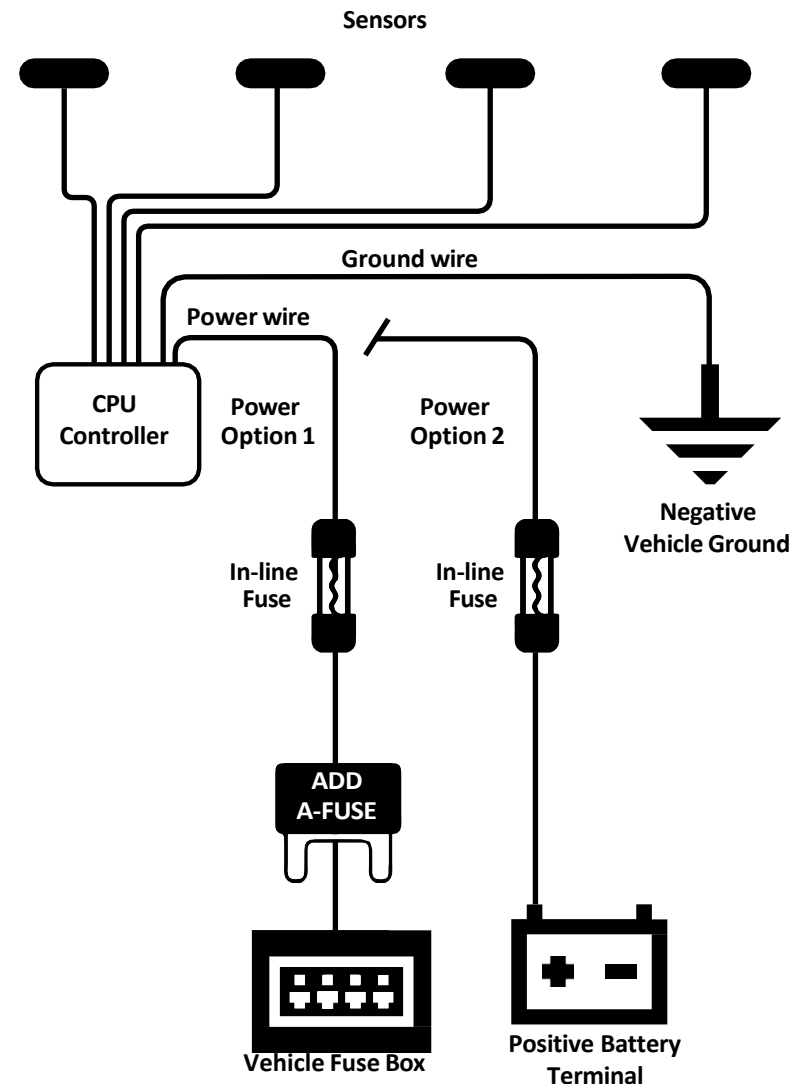

CHAPTER 2: Operation

Adjusting Volume

Press the + and - side buttons to adjust the volume. Press for 1 second to reach the maximum or minimum volume level. (15 is the maximum).

Receive only Mode

Press the RCV button to switch to receive only mode. This mode only receives Laser, and does not jam. Pressing the RCV button again will enable *Auto Sleep* mode. Adjustable jamming default is 4 seconds.

SLP (Auto/Quiet)

Pressing one second enables Auto sleep mode, this stops jamming function after selected Auto kill by the TMG Defender Lite App, Or a third party App. Auto sleep mode will take 1 minute to relay back to 4 second jamming from RCV only mode. Use caution for 1 minute because laser alerts will be muted until the CPU announces "Auto sleep mode off". Press the SLP/RPT button for 1 second to report police to the server. "Test mode" is recommended only for testing the jamming capability.

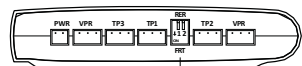
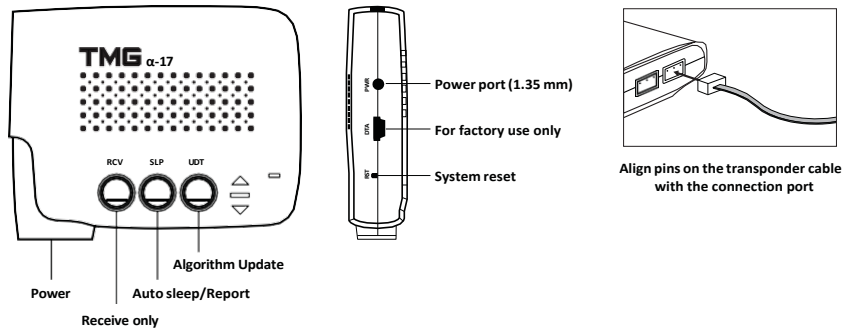

Note: Do not mix-up Standard & VPR head connections

VPR heads are intended for (variable pulse rate) lidar guns.
VPR ports: For front and rear VPR heads.
TP3: Front heads only
TP1: Front or Rear heads (dip switch controlled)
TP2: Front or Rear heads (dip switch controlled)

You can also flip both dip switches down to FRT, if you are not running any rear sensors. All ports will alert for "Front Laser"

Note: VPR heads will only work on short or long single cables, not the splitter cables

The side PWR port can be used to power the unit with a 12v barrel connector 1.3 mm.

Algorithm firmware Update - This firmware uploads the Lidar gun algorithms to the CPU. (Must have strong Internet access) These updates will become available as more police lidar gun pulse-trains are captured.

1. Connect to your iOS or Android device by the Starting the TMG Defender Lite App or the TMG Updater App instructions mentioned above.
2. Once connected, push the UDT button on the CPU.
3. An audio voice will say "Algorithm update open app and select new algorithm and enable Bluetooth"
4. Press the Algo update tab on the App, and you will hear an audio voice say "Start transferring" select OK on the instruction screen.
5. The Algo firmware will load up on top, by the loading bar, followed by the green indicator light flashing on the app, and a blinking UDT CPU button.
6. The CPU will reset and announce "Update finished or aborted returning to defender mode" to confirm the upload.

CPU Control Firmware- This firmware uploads changes, or updates in the CPU only. (This is not a common firmware to update)

1. Power on the TMG a-17 CPU, and pin the RST button on the side of the CPU for 2 seconds. A small red constant LED will appear on the CPU.
2. Open the App and Connect to your device by Bluetooth.
3. Press the CTRL update tab on the App and select OK.
4. "Start transferring" audio will announce.
5. The firmware will upload, followed by the small red LED flashing on the CPU, green indicator flashing on the app
6. An Audio voice will announce "System On" with a power cycle to confirm the update.

App operation

The TMG a-17 system can be paired with an Android or IOS device.

The following apps are available, TMG Updater on Android devices and TMG Defender Lite App on IOS devices.

JBV1 Android app, paired with a Valentine One Radar detector, and TMG Remote on Android. JBV1, and TMG Remote are made by John Boy Software.

Starting the TMG Laser defender Lite App on Android or IOS

1. Power on the TMG a-17 CPU
2. To begin pairing, press the Bluetooth icon on the far right side of the app. Do not attempt to pair using the system's Bluetooth pairing. Pair within the app itself.
3. Select scan and choose the "LD" that appears and type 1234 as the password. 0000 is also another password to try.
4. The blue Bluetooth light on the CPU will light up. You are now connected.
5. From the App you can have full access to the CPU buttons, adjust Auto-kill seconds, and adjust the sleep time in between alerts.
6. You can now update gun algorithms, and CPU control firmware.

**Note- The firmware servers are only available on the TMG Laser Defender Lite App.*

CHAPTER 3: Troubleshooting

Q: The CPU is not powering on?

A: Make sure the power port is plugged in snug. Make sure all electrical wires have good connections, Check for a blown fuse in the hardwire power cable.

Q: Why aren't my heads receiving a Laser alert when shot by Police?

A: Make sure your Volume is turned up high enough to hear over road noise and loud music, and is not on zero. The Officer may have not targeted you specifically, or pulled the trigger. Make sure your sensor cables are all plugged in, and lined up correctly by the arrows. A laser tester will confirm a Laser alert. A faulty head will not alert to Laser.

Q: Why is my CPU locked up?

A: Try a soft reset by a 1 second push on the RST button. The firmware did not upload correctly, The CPU case was smashed causing a button to be stuck. CPU notices a bad head.

Q: How do i know if i have a bad sensor, or the sensor has head failure?

A: The CPU can lock up, The CPU bluetooth light will randomly flash rapid upon start up, The fuse in the hardwire will keep blowing. The sensor will run hot compared to the others. Please call Customer support for a replacement.

Q: Why does the CPU keep announcing "Algorithm update" and is frozen?

A: Try to re-upload the Algo, or CPU control firmware.

Q: Why will the App not load up a firmware?

A: Make sure your device has a 4G service, or a strong WIFI connection. Make sure you are not in a third party app.

CHAPTER 4: Warranty

For a period of one year from the date of purchase by the consumer Facets TMG will repair or replace, at Facets TMG's discretion, defective products upon delivery to Facets or an authorized Service agent. Facets products must include a proof of purchase with the date it was first purchased from an authorized dealer, such as a copy of a sales receipt.

The customer must pay for shipping Facets products to an authorized Facets Service Agent. If the product is proven to be under warranty, the return charge, to the customer, will be at our expense.

This limited warranty does not apply:

- To any product damaged by a collision.
- In the event of misuse, abuse of the product, faulty installation, or as a result of unauthorized alterations or repairs.
- If the serial number has been altered, defaced, or removed.

All implied warranties, including warranties of merchantability and fitness for a particular purpose are limited in duration to the length of this warranty.

License Agreement

Facets products are made by Facets Product Design and Development Ltd in Taiwan. Facets and its licensors grant to the purchaser a non-transferable, non-exclusive license to use the software and data installed on Facets' products and the related documentation solely for personal use only on such Facets products. The purchaser should not copy, reverse engineer, translate, port, modify or make derivative works of the software and data. The purchaser should not loan, rent, disclose, publish, sell, assign, lease, sublicense, market or otherwise transfer the software and data or use it in any manner not expressly authorized by this agreement. By using this product, the purchaser agrees to be bound by the terms and conditions of this license agreement. Facets and its licensors shall retain all copyright, trade secret, patent and other proprietary ownership rights in the software and data. The software and data is copyrighted and may not be copied, even if modified or merged with other products. The purchaser shall not alter or remove any copyright notice or proprietary legend contained in or on the software and data. The purchaser may transfer all of his/her license rights in the software, data, the related documentation and a copy of this License Agreement to another party, provided that the party reads and agrees to accept the terms and conditions of this License Agreement. The software and data are provided to the purchaser "AS IS". Facets and its licensors make and you receive no warranty for the software and data, whether express or implied, and all warranties of merchantability and fitness for any particular purpose for the software and data are expressly excluded. The software and data is complex. Facets and its licensors intend to provide their customers the most complete and accurate information available at a reasonable cost from government and private data sources. However, all data sources have limitations and some have inaccuracies or are incomplete in some degree. As such, Facets and its licensors do not make any warranty regarding the accuracy or completeness of data used by this product and shall not be liable to the user for any incidental, consequential, special, indirect or exemplary damages including any fine, civil or criminal penalties arising from the use of the product.

CHAPTER 5: Appendix

Protection

Below is a collection of laser/lidar guns we have tested. Our laser jammer works for other similar ones. The coverage is increasing and we always keep our products promptly updated.



When testing the system at any time, such as on a bench or a temporary install, unwrap all cables. Testing with the cables wrapped up can cause a magnetic field, and the heads performance may be compromised.